

# **ANKER FLEXCO**

**TRANSPORTBAND-VERBINDUNGSSYSTEME  
CONVEYOR BELT FASTENING SYSTEMS  
SYSTÈMES D'AGRAFAGE POUR BANDES TRANSPORTEUSES**



**Programmübersicht**  
Alligator/Flexco/Tatch A Cleat



**Program Overview**  
Alligator/Flexco/Tatch A Cleat



**Gamme de produits**  
Alligator/Flexco/Tatch A Cleat

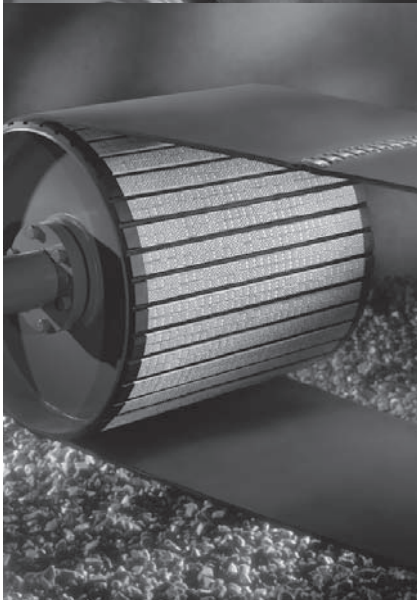



**ALLIGATOR Lacing**

Transportband - Verbindungssystem für Bandstärken bis 11 mm  
Conveyor Belt Fastening System for Belts up to 11 mm thick  
Système d'agrafage pour bandes transporteuses jusqu'à d'épaisseur 11 mm ..... 4

**ALLIGATOR Ready Set**

Transportband - Verbindungssystem für Bandstärken von 1,5 bis 6,4 mm  
Conveyor Belt Fastening System for Belts 1,5 to 6,4 mm thick  
Système d'agrafage pour bandes transporteuses d'épaisseur 1,5 - 6,4 mm ..... 6

**ALLIGATOR Plastic Rivet**

Plastikverbinder für Bandstärken von 1,6 - 3,2 mm  
Plastic Rivet Fasteners for Belts 1,6 - 3,2 mm thick  
Agrafes plastiques pour bandes transporteuses d'épaisseur 1,6 - 3,2 mm ..... 9

**ALLIGATOR Rivet**

Transportband - Verbindungssystem für Rundballenpressen  
Conveyor Belt Fastening System for Round Balers  
Système d'agrafage pour bandes transporteuses pour presses à balles ..... 10

**ALLIGATOR**

Keilriemenverbinder  
V-Belt Fasteners  
Agrafes pour courroies trapézoïdales ..... 11

**FLEXCO Bolt Hinged**

Transportband - Verbindungssystem für Bandstärken von 6 bis 16 mm  
Conveyor Belt Fastening System for Belts 6 to 16 mm thick  
Système d'agrafage pour bandes transporteuses d'épaisseur 6 - 16 mm ..... 12

**FLEXCO Rivet Hinged (Scalloped Edge)**

Transportband - Verbindungssystem für Bandstärken von 5 bis 17 mm  
Conveyor Belt Fastening System for Belts 5 to 17 mm thick  
Système d'agrafage pour bandes transporteuses d'épaisseur 5 - 17 mm ..... 14

**FLEXCO Rivet Solid Plate**

Transportband - Verbindungssystem für Bandstärken von 6 bis 24 mm  
Conveyor Belt Fastening System for Belts 6 to 24 mm thick  
Système d'agrafage pour bandes transporteuses d'épaisseur 6 - 24 mm ..... 19

**FLEXCO Bolt Solid Plate**

Transportband - Verbindungssystem für Bandstärken von 5 bis 30 mm  
Conveyor Belt Fastening System for Belts 5 to 30 mm thick  
Système d'agrafage pour bandes transporteuses d'épaisseur 5 - 30 mm ..... 20

**Extra Schrauben und Muttern**

**Extra Bolts and Nuts**

**Vis et écrous supplémentaires** ..... 23

**ALLIGATOR/FLEXCO Bandschneider und Bandspanner**

**ALLIGATOR/FLEXCO Belt Cutters and Belt Clamps**

**ALLIGATOR/FLEXCO Coupeuses de bande et pinceurs de bande** ..... 24

**ALLIGATOR/FLEXCO**

**Zubehör, Accessories, Accessoires** ..... 25

**TATCH A CLEAT**

Schraubstollen und Führungsprofile  
Mechanical Belt Cleats and Guides  
Profils à vis et de guidage ..... 26

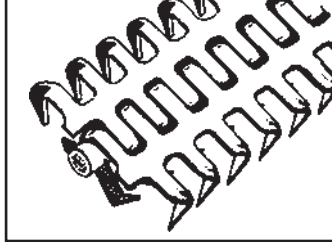

## ALLIGATOR Lacing

Transportband -  
Verbindungssystem für  
Bandstärken bis 11 mm

Conveyor Belt Fastening  
System for Belts up to  
11 mm thick

Système d'agrafage pour  
bandes transporteuses  
jusqu'à d'épaisseur 11 mm

Verbindergroße Fastener Size Taille des agrafes	empf. Bandstärkenbereich Belt Thickness Range Épaisseur de bandes recommandée mm	empf. kleinster Trommel-Ø rec. min. Pulley-Ø Ø tambour mini.rec. mm
<b>00</b>	- 1,6	25
<b>1</b>	1,6 - 2,4	40
<b>7</b>	2,4 - 3,6	50
<b>15</b>	3,2 - 4,0	65
<b>20</b>	4,0 - 4,8	75

Verbindergroße Fastener Size Taille des agrafes	empf. Bandstärkenbereich Belt Thickness Range Épaisseur de bandes recommandée mm	empf. kleinster Trommel-Ø rec. min. Pulley-Ø Ø tambour mini.rec. mm
<b>25</b>	4,8 - 5,6	100
<b>27</b>	5,6 - 7,1	125
<b>35</b>	7,1 - 7,9	175
<b>45</b>	7,9 - 9,5	230
<b>55</b>	9,5 - 11,0	300

**Inhalt:** Jeder Karton enthält 4  
komplette Verbindungen für  
die angegebene Bandbreite.

**Content:** Each Box contains 4  
Sets Lacing for the Belt Width  
specified.

**Contenu:** Chaque boîte contient 4  
jeux complets de jonction pour la  
largeur de bande spécifiée.

### Stahl / Steel / Acier

Bestell-Nr. Order-No. No. de réf.	Bandbreite Belt Width Larg. de bande mm	Gewicht Weight Poids kg
<b>00</b> (4 Verbindersets / Fastener Sets / Jeux de jonction)		
<b>00-300</b>	300	0,14
<b>00-600</b>	600	0,28
<b>00-900</b>	900	0,42
<b>00-1200</b>	1200	0,57
<b>1A</b>		
<b>1A-300</b>	300	0,25
<b>1A-600</b>	600	0,49
<b>1A-900</b>	900	0,73
<b>1A-1000</b>	1000	0,82
<b>1A-1200</b>	1200	0,98
<b>1A-1500</b>	1500	1,22
<b>7</b>		
<b>7-300</b>	300	0,32
<b>7-600</b>	600	0,64
<b>7-900</b>	900	0,96
<b>7-1000</b>	1000	1,07
<b>7-1200</b>	1200	1,28
<b>7-1500</b>	1500	1,61
<b>15</b>		
<b>15-300</b>	300	0,46
<b>15-600</b>	600	0,91
<b>15-900</b>	900	1,37
<b>15-1200</b>	1200	1,83
<b>15-1500</b>	1500	2,29
<b>20</b>		
<b>20-300</b>	300	0,60
<b>20-600</b>	600	1,20
<b>20-900</b>	900	1,81
<b>20-1200</b>	1200	2,42

### Stahl / Steel / Acier

Bestell-Nr. Order-No. No. de réf.	Bandbreite Belt Width Larg. de bande mm	Gewicht Weight Poids kg
<b>25</b> (4 Verbindersets / Fastener Sets / Jeux de jonction)		
<b>25-300</b>	300	0,68
<b>25-600</b>	600	1,35
<b>25-900</b>	900	2,03
<b>25-1200</b>	1200	2,70
<b>27</b>		
<b>27-300</b>	300	0,80
<b>27-600</b>	600	1,60
<b>27-900</b>	900	2,38
<b>27-1200</b>	1200	3,18
<b>35</b>		
<b>35-300</b>	300	1,28
<b>35-600</b>	600	1,60
<b>35-900</b>	900	3,84
<b>35-1200</b>	1200	5,12
<b>45</b>		
<b>45-300</b>	300	1,51
<b>45-600</b>	600	3,17
<b>45-900</b>	900	4,75
<b>45-1200</b>	1200	6,34
<b>55</b>		
<b>55-300</b>	300	2,17
<b>55-600</b>	600	4,34
<b>55-900</b>	900	6,34
<b>55-1200</b>	1200	8,70

## Rostfrei / Stainless / Inoxydable

Bestell-Nr. Order-No. No. de réf.	Bandbreite Belt Width Larg. de bande mm	Gewicht Weight Poids kg
---	--	----------------------------------

### 00S (4 Verbindersets / Fastener Sets / Jeux de jonction)

<b>00S-300</b>	300	0,14
<b>00S-600</b>	600	0,28
<b>00S-900</b>	900	0,42
<b>00S-1200</b>	1200	0,57

### 1S

<b>1S-300</b>	300	0,25
<b>1S-600</b>	600	0,49
<b>1S-900</b>	900	0,73
<b>1S-1000</b>	1000	0,82
<b>1S-1200</b>	1200	0,98
<b>1S-1500</b>	1500	1,22

## Gelenkriemen- verbinder

## Transmission Belt Lacing

### Stahl / Steel / Acier

Bestell-Nr. Order-No. No. de réf.	Verbinder Sets Fastener Sets Jeux de jonction	Gewicht Weight Poids kg
---	---	----------------------------------

<b>00</b>	6 X 150	0,09
<b>1A</b>	6 X 150	0,15
<b>7</b>	6 X 150	0,20
<b>15</b>	8 X 300	0,41
<b>20</b>	8 X 300	0,55
<b>25D</b>	8 X 300	0,64
<b>27K</b>	8 X 300	0,78
<b>35N</b>	8 X 300	1,23
<b>45U</b>	8 X 300	1,50
<b>55W</b>	8 X 300	2,14
<b>65X</b>	8 X 300	2,63

## Eco Pack

Jede VPE enthält 10 Verbindersets, einzeln verpackt.

Each package contains 10 sets of lacing, individually packed.

Chaque unité d'emballage comprend 10 jeux de jonction, emballés individuellement.

Bestell-Nr. Order-No. No. de réf.	Verbinder Sets Fastener Sets Jeux de jonction	Gewicht Weight Poids kg
---	---	----------------------------------

<b>15E</b>	10 X 300	0,41
<b>20E</b>	10 X 300	0,55
<b>25E</b>	10 X 300	0,64
<b>27E</b>	10 X 300	0,78
<b>35E</b>	10 X 300	1,23

## Rostfrei / Stainless / Inoxydable

Bestell-Nr. Order-No. No. de réf.	Bandbreite Belt Width Larg. de bande mm	Gewicht Weight Poids kg
---	--	----------------------------------

### 7S

<b>7S-300</b>	300	0,32
<b>7S-600</b>	600	0,64
<b>7S-900</b>	900	0,96
<b>7S-1000</b>	1000	1,07
<b>7S-1200</b>	1200	1,28
<b>7S-1500</b>	1500	1,61

## Agrafes flexibles pour courroies de transmission

### Rostfrei / Stainless / Inoxydable

Bestell-Nr. Order-No. No. de réf.	Verbinder Sets Fastener Sets Jeux de jonction	Gewicht Weight Poids kg
---	---	----------------------------------

<b>00S</b>	6 X 150	0,09
<b>1AS</b>	6 X 150	0,15
<b>7S</b>	6 X 150	0,20
<b>15S</b>	8 X 300	0,41
<b>20S</b>	8 X 300	0,55
<b>25DS</b>	8 X 300	0,64
<b>27KS</b>	8 X 300	0,78
<b>35NS</b>	8 X 300	1,23
<b>45US</b>	8 X 300	1,50
<b>55WS</b>	8 X 300	2,14



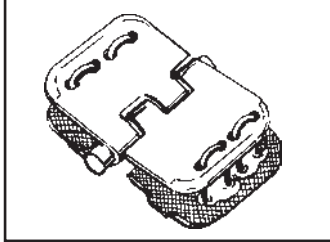

## ALLIGATOR Ready Set

Transportband-  
Verbindungssystem für  
Bandstärken von  
1,5 - 6,4 mm

Conveyor Belt Fastening  
System for Belts 1,5 - 6,4  
mm thick

Système d'agrafage pour  
bandes transporteuses  
d'épaisseur 1,5 - 6,4 mm

Verbindergroße Fastener Size Taille des agrafes	Für Transportbänder bis zu... N/mm Festigkeit For Belts with a Tensile Strength of up to... N/mm Pour bandes tranporteuses à résistance de rupture jusqu'à... N/mm	empf. Bandstärkenbereich Belt Thickness Range Épaisseur de bandes recommandée mm	empf. kleinster Trommel-Ø rec. min. Pulley-Ø Ø tambour mini.rec. mm
<b>RS62</b>	200	1,5 - 3,2	50
<b>RS125</b>	315	3,2 - 4,8	75
<b>RS187</b>	400	4,8 - 6,4	100

**Inhalt:** Jeder J-Karton enthält 4  
komplette Verbindungen für  
die angegebene Bandbreite.

**Content:** Each J-box contains 4  
Sets Lacing for the Belt Width  
specified.

**Contenu:** Chaque boîte J contient  
4 jeux complets de jonction  
pour la largeur de bande spécifiée.

### Stahl verzinkt Galvanized Steel / Acier galvanisé

Bestell-Nr. Order-No. No. de réf.	Bandbreite Belt Width Larg. de bande mm	Gewicht Weight Poids kg
<b>RS62J12/300NC</b>	300	0,61
<b>RS62J24/600NC</b>	600	1,22
<b>RS62J32/800NC</b>	800	1,64
<b>RS62J40/1000NC</b>	1000	2,05
<b>RS62J47/1200NC</b>	1200	2,44
<b>RS62J59/1500NC</b>	1500	3,05
<b>RS125J12/300NC</b>	300	0,91
<b>RS125J24/600NC</b>	600	1,78
<b>RS125J32/800NC</b>	800	2,43
<b>RS125J40/1000NC</b>	1000	3,04
<b>RS125J47/1200NC</b>	1200	3,65
<b>RS125J59/1500NC</b>	1500	4,56
<b>RS187J12/300NC</b>	300	1,16
<b>RS187J24/600NC</b>	600	2,69
<b>RS187J32/800NC</b>	800	3,36
<b>RS187J40/1000NC</b>	1000	4,20
<b>RS187J47/1200NC</b>	1200	5,33
<b>RS187J59/1500NC</b>	1500	6,26

### Rostfrei Stainless / Inoxydable

Bestell-Nr. Order-No. No. de réf.	Bandbreite Belt Width Larg. de bande mm	Gewicht Weight Poids kg
<b>RS62SJ12/300NCS</b>	300	0,61
<b>RS62SJ24/600NCS</b>	600	1,22
<b>RS62SJ32/800NCS</b>	800	1,64
<b>RS62SJ40/1000NCS</b>	1000	2,05
<b>RS62SJ47/1200NCS</b>	1200	2,44
<b>RS62SJ59/1500NCS</b>	1500	3,05
<b>RS125SJ12/300NCS</b>	300	0,91
<b>RS125SJ24/600NCS</b>	600	1,78
<b>RS125SJ32/800NCS</b>	800	2,43
<b>RS125SJ40/1000NCS</b>	1000	3,04
<b>RS125SJ47/1200NCS</b>	1200	3,65
<b>RS125SJ59/1500NCS</b>	1500	4,56
<b>RS187SJ12/300NCS</b>	300	1,16
<b>RS187SJ24/600NCS</b>	600	2,69
<b>RS187SJ32/800NCS</b>	800	3,36
<b>RS187SJ40/1000NCS</b>	1000	4,20
<b>RS187SJ47/1200NCS</b>	1200	5,33
<b>RS187SJ59/1500NCS</b>	1500	6,26

25 Verbindersets (ohne Kupplungsstäbe) · 25 Fastener Sets (without Hinge Pins) · 25 Jeux de jonction (sans axe)

<b>RS62-47/1200-25</b>	1200	13,50
<b>RS125-47/1200-25</b>	1200	18,70
<b>RS187-47/1200-25</b>	1200	27,50

<b>RS62S-47/1200-25</b>	1200	13,50
<b>RS125S-47/1200-25</b>	1200	18,70
<b>RS187S-47/1200-25</b>	1200	27,50

### MegAlloy

Bestell-Nr. Order-No. No. de réf.	Inhalt Content Contenu	Gewicht Weight Poids kg
<b>125MA</b>	8 X 300 mm	1,9
<b>187MA</b>	8 X 300 mm	2,6

### Extra Klammern, rostfrei · Extra Staples, stainless Crampons supplémentaires, inoxydables

Bestell-Nr. Order-No. No. de réf.	Verbindergroße Fastener size Taille d'agrafe	Inhalt Content Contenu	Gewicht Weight Poids kg
<b>S125</b>	125	990	0,41
<b>S187</b>	187	990	0,46

<b>Kupplungsdrähte Hinge Material Axes de jonction</b>	Bestell-Nr. Order-No. No. de réf.	Ø mm	Verbindergröße Fastener Size Taille d'agrafe	Inhalt Content Contenu	Gewicht Weight Poids kg	
<b>NC</b>	<b>NC62-X</b>	2,0	RS62	3 m	0,05	
	<b>NC62-C</b>			30 m	0,45	
	<b>NC1-X</b>	3,6	RS125	3 m	0,09	
	<b>NC1-C</b>			30 m	0,77	
	<b>NC187-X</b>	5,2	RS187	3 m	0,09	
	<b>NC187-C</b>			30 m	2,17	
<b>NCS</b>	<b>NCS62-X</b>	2,0	RS62	3 m	0,05	
	<b>NCS62-C</b>			30 m	0,45	
	<b>NCS1-X</b>	3,6	RS125	3 m	0,09	
	<b>NCS1-C</b>			30 m	0,77	
	<b>NCS187-X</b>	5,2	RS187	3 m	0,09	
	<b>NCS187-C</b>			30 m	2,17	
<b>SP</b> * Bandbreite (mm) * Belt Width (mm) * Largeur de bande (mm)	<b>SP62-1000</b>	2,0	RS62	10 X 1000* mm	0,32	
	<b>SP62-1200</b>			10 X 1200* mm	0,37	
	<b>SP62-1500</b>			10 X 1500* mm	0,40	
	<b>SP1-1000</b>	3,6	RS125	10 X 1000* mm	0,68	
	<b>SP1-1200</b>			10 X 1200* mm	0,87	
	<b>SP1-1500</b>			10 X 1500* mm	1,00	
	<b>SP2-1000</b>	4,7	RS187	10 X 1000* mm	1,23	
	<b>SP2-1200</b>			10 X 1200* mm	1,55	
	<b>SP2-1500</b>			10 X 1500* mm	1,80	
	<b>SS</b> * Bandbreite (mm) * Belt Width (mm) * Largeur de bande (mm)	<b>SS62-1000</b>	2,0	RS62	10 X 1000* mm	0,32
<b>SS62-1200</b>		10 X 1200* mm			0,37	
<b>SS62-1500</b>		10 X 1500* mm			0,42	
<b>SS1-1000</b>		3,6	RS125	10 X 1000* mm	0,68	
<b>SS1-1200</b>				10 X 1200* mm	0,87	
<b>SS1-1500</b>				10 X 1500* mm	1,00	
<b>SS2-1000</b>		4,7	RS187	10 X 1000* mm	1,23	
<b>SS2-1200</b>				10 X 1200* mm	1,55	
<b>SS2-1500</b>				10 X 1500* mm	1,95	
Kupplungsstab-Sicherungs- scheiben		<b>62-RET-50</b>		RS62	50	0,04
		<b>125-RET-50</b>		RS125	50	0,05
Hinge Pin Retaining Washers		<b>187-RET-50</b>		RS187	50	0,06
Rondelles de butée pour axes de jonction	<b>310-RET-50</b>		375X/550/R2/R5	50	0,15	
Kupplungsstab-Bieger Pin Bender Outil à plier l'axe de jonction	<b>PB1</b>				0,5	

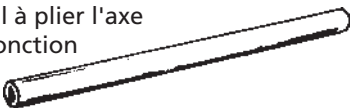

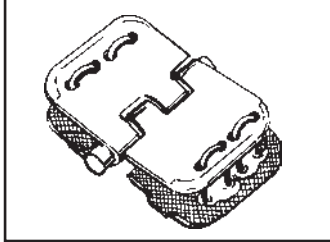

## ALLIGATOR Ready Set

Montagewerkzeuge und  
Zubehör

Installation Tools and  
Accessories

Outils de montage et  
accessoires

### RSTK-Werkzeugkoffer

mit RSC187-Gerät, Klammersetzplatte,  
Hammer, Rillenhobel, Bänder-  
trimmzange.

### RSTK-Staple Kit

with RSC187 Installation Tool, Staple  
Set Plate, Hammer, Hand Skiver,  
Belt Nippers.

### RSTK-Coffret d'outillage

avec appareil de montage RSC187,  
plaque de pose de crampons, marteau,  
rabot pour courroie, pince à rogner.

Bestell-Nr.  
Order-No.  
No. de réf.

Gerät  
Tool  
Outil

Gewicht  
Weight  
Poids  
kg

**RSTK4-6**  
**RSTK4-12**

RSC187-6  
RSC187-12

8,8  
12,1

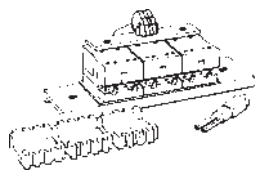

### Montagegeräte Staple Driving Tools Appareils de montage

**RSC187**  
**RSC187-4**  
**RSC187-6**  
**RSC187-12**  
**RSC187-18**  
**RSC187-24**  
**RSC187-36**  
**RSC187-48**  
**RSC187-60**

50  
100  
150  
300  
450  
600  
900  
1200  
1500

0,5  
1,5  
3,0  
5,0  
7,5  
9,0  
14,0  
17,0  
25,0

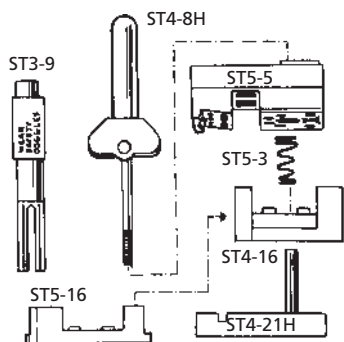

### Ersatzteile Spare Parts Pièces de rechange

**ST5-3**  
**ST3-9**  
**ST6-9**  
**ST4-8H**  
  
**ST4-16**  
**ST5-16**  
**ST5-5**  
**ST3-13**  
**ST3-14**  
**ST3-15-6**  
**ST4-21H**

Druckfeder / Spring / Ressort de pression  
Klammertreiber / Staple Driver / Chasoir de crampons  
Klammertreiber / Staple Driver / Chasoir de crampons  
Nockenhebel komplett / Cam Lever Assembly /  
Levier de tension complet (> RSC187-6)  
Kamm grün / Comb green / Peigne vert (125/187)  
Kamm gelb / Comb yellow / Peigne jaune (62/125)  
Führungsblock / Guide Block / Bloc de guidage  
Schraube / Bolt / Vis  
Fixierstift / Cam Locating Pin / Goupille  
Klemmschiene / Clamp Bar / Rail de serrage  
Amboßsegment / Anvil / Segment d'enclume

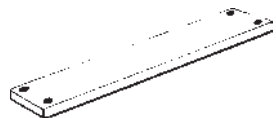

### Klammersetzplatte Staple Set Plate Plaque de pose de crampons

**ST-28**

2,3

### Pressbacken für hydraulische Maschinen Press Plates for Hydraulic Lacers Mâchoires pour agrafeuses hydrauliques

Bestell-Nr.  
Order-No.  
No. de réf.

Für  
For  
Pour

Gewicht  
Weight  
Poids  
kg

**P2AS**  
**P6AS**

ARK 150/200/ARU 2000  
AMK 400/AMU 4000/6000

3,0  
5,0

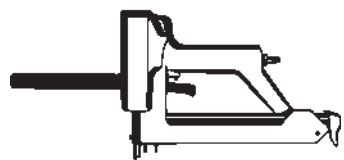

### Druckluftnagler und Zubehör Air powered Nail Gun and Accessories Cloueur pneumatique et accessoires

Bestell-Nr.  
Order-No.  
No. de réf.

Für  
For  
Pour

Gewicht  
Weight  
Poids  
kg

**SPD-1**  
**FP**  
**SGB-2**  
**SGB-6**

RS62, 125, 187  
RS62, 125, 187  
RS62, 125, 187  
RS62, 125, 187

2,2  
0,1  
0,2  
0,8



# ALLIGATOR Plastic Rivet

Plastikverbinder  
für Bandstärken  
von 1,6 - 3,2 mm

Plastic Rivet Fasteners  
for Belts  
1,6 - 3,2 mm thick

Agrafes plastiques pour  
bandes transporteuses  
d'épaisseur 1,6 - 3,2 mm

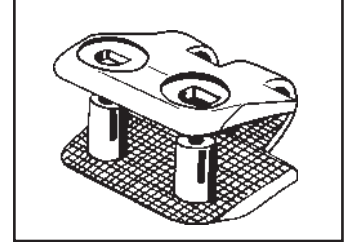

Verbindergröße Fastener Size Taille des agrafes	Für Transportbänder bis zu... N/mm Festigkeit For Belts with a Tensile Strength of up to... N/mm Pour bandes transporteuses à résistance de rupture jusqu'à... N/mm	empf. Bandstärkenbereich Belt Thickness Range Épaisseur de bandes recommandée mm	empf. kleinster Trommel-Ø rec. min. Pulley-Ø Ø tambour mini.rec. mm
<b>APF100</b>	75	-2,4	38
<b>APF150</b>	100	1,6 - 3,2	75

## Plastikverbinder · Non metallic Fasteners · Agrafes plastiques

Bestell-Nr. Order-No. No. de réf.	Inhalt Content Contenu	Gewicht Weight Poids kg	Bestell-Nr. Order-No. No. de réf.	Inhalt Content Contenu	Gewicht Weight Poids kg
<b>APF 100W-100*</b>	100	0,29	<b>APF 150W-100*</b>	100	0,45
<b>APF 100W-500**</b>	500	0,61	<b>APF 150W-500**</b>	500	0,97
<b>APF 100B-100*</b>	100	0,29	<b>APF 150B-100*</b>	100	0,45
<b>APF 100B-500**</b>	500	0,61	<b>APF 150B-500**</b>	500	0,97

\* für Bandbreite 1200 mm

\* for belt width of 1200 mm

\* pour une épaisseur de bande de 1200 mm

\*\* ausreichend für 6 m Verbindung

\*\* sufficient for 6 m splice

\*\* suffit pour 6 m de jonction

## Kupplungsdrähte · Hinge Material · Axes de jonction

Bestell-Nr. Order-No. No. de réf.	Länge Length Longueur m	Gewicht Weight Poids kg	Bestell-Nr. Order-No. No. de réf.	Länge Length Longueur m	Gewicht Weight Poids kg
<b>NK2,50</b>	30	0,20	<b>NK3,50</b>	30	0,40

## Montagegerät und Zubehör · Installation Tool and Accessories · Outillage de montage et accessoires

Bestell-Nr. Order-No. No. de réf.	Gewicht Weight Poids kg	Bestell-Nr. Order-No. No. de réf.	Gewicht Weight Poids kg
<b>MDT220-1</b>	15,90	<b>PRL4</b>	0,17
<b>PCA7-600</b>	4,08		

## Bohrschablonen · Templets · Gabarits

<b>100T-600</b>	0,63	<b>150T-600</b>	0,57
<b>100T-1200</b>	1,13	<b>150T-1200</b>	1,08

## Locheisen · Belt Punch · Poinçon

<b>A100P</b>	0,03	<b>A150P</b>	0,03
--------------	------	--------------	------

## Nietkopf · Curling Bit · Tête de pose

<b>S100B</b>	0,03	<b>S150B</b>	0,03
--------------	------	--------------	------

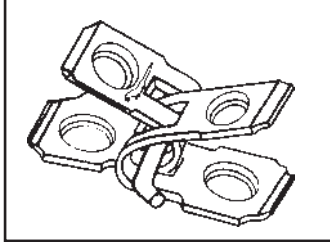

## ALLIGATOR Rivet

Transportband-  
Verbindungssystem für  
Rundballenpressen

Conveyor Belt Fastening  
System for Round Balers

Système d'agrafage pour  
bandes transporteuses  
pour presses à balles

Verbindergroße Fastener Size Taille des agrafes	Für Transportbänder bis zu... N/mm Festigkeit For Belts with a Tensile Strength of up to... N/mm Pour bandes tranporteuses à résistance de rupture jusqu'à... N/mm	empf. Bandstärkenbereich Belt Thickness Range Épaisseur de bandes recommandée mm	empf. kleinster Trommel-Ø rec. min. Pulley-Ø Ø tambour mini.rec. mm
<b>AR</b>	400	3,2 - 5,6	90

### Verbinder · Fasteners · Agrafes

Bestell-Nr. Order-No. No. de réf.	Bandbreite Belt Width Larg. de bande mm	Verbindungen Fastener Sets Jeux d'agrafes
<b>ARJ4/100</b>	100	2
<b>ARJ6/150</b>	150	2
<b>ARJ7/175</b>	175	2
<b>ARJ7/175-6</b>	175	6
<b>ARJ220</b>	220	6
<b>ARJ10/250</b>	250	2
<b>ARJ14/350</b>	350	2



### Extra Kupplungsstäbe und Nieten Extra Hinge Pins and Rivets Axes et rivets supplémentaires

Bestell-Nr. Order-No. No. de réf.	Bandbreite Belt Width Larg. de bande mm	Inhalt Content Contenu
gehärteter Stahl, gerillt/steel corrugated, heat-treated/acier rainuré, trempé		
<b>ARSH4/100</b>	100	9
<b>ARSH6/150</b>	150	8
<b>ARSH7/175</b>	175	8
<b>ARSH10/250</b>	250	4
<b>ARSH14/350</b>	350	4
Federstahl, rostfrei/Spring steel, stainless/Acier à ressort, inoxydable		
<b>ARSS1-4/100</b>	100	9
<b>ARSS1-6/150</b>	150	8
<b>ARSS1-7/175</b>	175	8
<b>ARSS1-10/250</b>	250	4
<b>ARSS1-14/350</b>	350	4
<b>AR3-15</b>	Nieten/Rivets	15

### Geräte · Tools · Outils

Bestell-Nr. Order-No. No. de réf.	Gerätebreite Tool Width Largeur d'outil mm
<b>ART-7</b>	175
<b>ART-10</b>	250
<b>ART-14</b>	350



### ARTK-Gerätekoffer

mit ART-Gerät, Rillenhobel, Hammer, Kupplungsstababbieger und 2 Kartons ARJ-Verbindersets in einem Plastikkoffer

### ARTK-Toolkit

includes ART Installation Tool, Hand Belt Skiver, Hammer, Pin Bender and 2 packages of ARJ fasteners in a plastic tool box

### Coffret ARTK

Contenu: outil de pose, rabot pour courroie, marteau, outil pour plier les axes et 2 cartons de jeux d'agrafes ARJ dans un coffret plastique

Bestell-Nr. Order-No. No. de réf.	Gerätebreite Tool Width Largeur d'outil mm
<b>ARTK-7</b>	175
<b>ARTK-14</b>	350



# ALLIGATOR

Keilriemenverbinder

V-Belt Fasteners

Agrafes pour courroies trapézoïdales

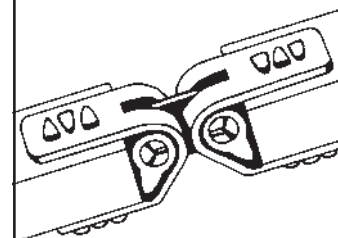

## Keilriemenverbinder V-Belt Fasteners Agrafes pour courroies trapézoïdales

Bestell-Nr. Order-No. No. de réf.	Sets/Krt. Sets/Box Jeux/bte.	Gewicht Weight Poids kg
<b>A312</b>	10	0,15
<b>A312S</b>	5	0,10
<b>B437</b>	10	0,20
<b>BB4</b>	10	0,18
<b>C531</b>	10	0,54
<b>D750</b>	10	0,97

## Keilriemen V-Belt (conventional) Courroies trapézoïdales

Bestell-Nr. Order-No. No. de réf.	Breite Width Largeur m	Gewicht Weight Poids kg
<b>AV20</b>	6	0,82
<b>AV100</b>	30	4,08
<b>AV250</b>	76	10,21
<b>BV20</b>	6	1,18
<b>BV100</b>	30	5,89
<b>BV250</b>	76	14,74
<b>CV100</b>	30	9,97
<b>CV250</b>	76	24,95
<b>DV100</b>	30	21,32
<b>DV200</b>	60	42,64

## Montagewerkzeuge Installation Tools Outillage de montage

Bestell-Nr. Order-No. No. de réf.			Gewicht Weight Poids kg
<b>A31255</b>		Halter	0,03
<b>B43755</b>		Holder	0,10
<b>BB455</b>		Teneur	0,10
<b>C53155</b>			0,15
<b>B43740</b>		Rocker	0,05
<b>C62540</b>		Pin Tool	0,06
<b>B43750</b>		Spanner	0,43
<b>C53150</b>		Tightener	0,96
<b>D75050</b>		Pinceur	2,05
<b>C62520</b>		Schneider	0,68
<b>C62523</b>		Cutter	0,14
		Coupeuse	0,14

## Keilriemensatz V-Belt Kit / Jeu de courroies trapézoïdales

Jeder Karton enthält 30 m Keilriemen, 10 Verbinder und das erforderliche Montagewerkzeug.

Each Kit contains 30 m V-Belt, 10 Fasteners and the necessary Installation Tools.

Chaque boîte contient 30 m de courroie trapézoïdale, 10 agrafes et les outils de montage nécessaires.

Bestell-Nr. Order-No. No. de réf.	Gewicht Weight Poids kg
<b>A4</b>	4,11
<b>B3</b>	6,35
<b>BB3</b>	7,64
<b>C3</b>	10,89
<b>D3</b>	38,56

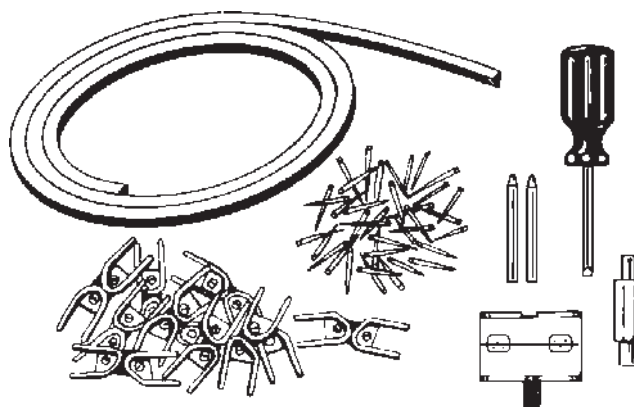

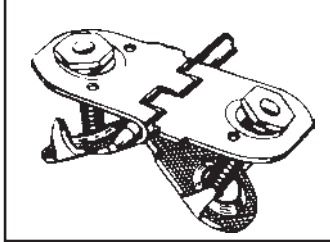

## FLESCO Bolt Hinged

Transportband -  
Verbindungssystem für  
Bandstärken  
von 6 bis 16 mm

Conveyor Belt Fastening  
System for Belts  
6 to 16 mm thick

Système d'agrafage pour  
bandes transporteuses  
d'épaisseur 6 - 16 mm

Verbindergroße Fastener Size Taille des agrafes	Für Transportbänder bis zu... N/mm Festigkeit For Belts with a Tensile Strength of up to... N/mm Pour bandes tranporteuses à résistance de rupture jusqu'à... N/mm	empf. Bandstärkenbereich Belt Thickness Range Épaisseur de bandes recommandée mm	empf. kleinster Trommel-Ø rec. min. Pulley-Ø Ø tambour mini.rec. mm
<b>375X</b>	400	6 - 10	125
<b>550</b>	500	6 - 16	200

**Inhalt:** Jeder J-Karton enthält 1 komplette Verbindung für die angegebene Bandbreite.

**Content:** Each J-Box contains 1 Set Lacing for the Belt Width specified.

**Contenu:** Chaque boîte J contient 1 jeu complet de jonction pour la largeur de bande spécifiée.

### Stahl verzinkt Galvanized Steel / Acier galvanisé

Bestell-Nr. Order-No. No. de réf.	Bandbreite Belt Width Larg. de bande mm	Gewicht Weight Poids kg
<b>375XJ400NC-SN</b>	400	1,28
<b>375XJ500NC-SN</b>	500	1,59
<b>375XJ650NC-SN</b>	650	2,07
<b>375XJ800NC-SN</b>	800	2,55
<b>375XJ1000NC-SN</b>	1000	3,18
<b>375XJ1200NC-SN</b>	1200	3,77
<b>375XJ1400NC-SN</b>	1400	4,46
<b>550J500NC-SN</b>	500	1,66
<b>550J650NC-SN</b>	650	2,16
<b>550J800NC-SN</b>	800	2,66
<b>550J1000NC-SN</b>	1000	3,32
<b>550J1200NC-SN</b>	1200	4,00
<b>550J1400NC-SN</b>	1400	4,65

### MegAlloy

<b>550MAJ650SC-SN</b>	650	2,1
<b>550MAJ800SC-SN</b>	800	2,7
<b>550MAJ1000SC-SN</b>	1000	3,3
<b>550MAJ1200SC-SN</b>	1200	4,0

### Lose-Verbinder (mit Schrauben und Muttern) Bulk Fasteners (with Bolts and Nuts) Plaques d'agrafes individuelles (avec vis et écrous)

#### Stahl / Steel / Acier

Bestell-Nr. Order-No. No. de réf.	Platten Plates Plaques	Sets/Eimer Sets/Bucket Jeux/seau	Gewicht Weight Poids kg
<b>375X-3-SN</b>	3	18	3,86
<b>550-1-SN</b>	1	50	5,44
<b>550-3-SN</b>	3	18	5,90

Extra Kupplungsstäbe auf Seite 15  
Extra Hinge Pins on Page 15  
Axes de jonction supplémentaires page 15

### Rostfrei Stainless / Inoxydable

Bestell-Nr. Order-No. No. de réf.	Bandbreite Belt Width Larg. de bande mm	Gewicht Weight Poids kg
<b>375XSJ400NCS</b>	400	1,28
<b>375XSJ500NCS</b>	500	1,59
<b>375XSJ650NCS</b>	650	2,07
<b>375XSJ800NCS</b>	800	2,55
<b>375XSJ1000NCS</b>	1000	3,18
<b>375XSJ1200NCS</b>	1200	3,77
<b>375XSJ1400NCS</b>	1400	4,46
<b>550SJ500SSC</b>	500	1,66
<b>550SJ650SSC</b>	650	2,16
<b>550SJ800SSC</b>	800	2,66
<b>550SJ1000SSC</b>	1000	3,32
<b>550SJ1200SSC</b>	1200	4,00
<b>550SJ1400SSC</b>	1400	4,65

### Antimagnetisch / Non magnetic / Anti-magnétique







<b>375XEJ500NB</b>	500	1,59
<b>375XEJ650NB</b>	650	2,07
<b>375XEJ800NB</b>	800	2,55
<b>375XEJ1000NB</b>	1000	3,18
<b>375XEJ1200NB</b>	1200	3,77
<b>550SJ650NB</b>	650	2,16
<b>550SJ800NB</b>	800	2,66
<b>550SJ1000NB</b>	1000	3,32
<b>550SJ1200NB</b>	1200	4,00
<b>550SJ1400NB</b>	1400	4,50

### Rostfrei / Stainless / Inoxydable

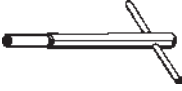
Bestell-Nr. Order-No. No. de réf.	Platten Plates Plaques	Sets/Krt. Sets/Box Jeux/bte.	Gewicht Weight Poids kg
<b>375XS-2</b>	2	25	2,86
<b>375XS-3</b>	3	18	3,68
<b>550S-1</b>	1	50	5,49

Extra Schrauben und Muttern auf Seite 23  
Extra Bolts and Nuts on Page 23  
Vis et écrous supplémentaires page 23

## Montagewerkzeuge · Installation Tools · Outils de montage

		Bestell-Nr. Order-No. No. de réf.	Verbindergroße Fastener Size Taille d'agrafe	Gewicht Weight Poids kg
<b>Manuelle Montage · Hand Tools · Montage manuel</b>				
	Schraubenbrecher Bolt Breaker Casse-vis	<b>110</b>	375 + 550	0,60
	Lochisen Punch Poinçon	<b>P1P</b>	375 + 550	0,06
	Schraubenschlüssel Wrench Clé à tube	<b>S1S</b>	375 + 550	0,09
<b>Für Schlagschrauber · Power Tools · Outils pour boulonneuse à percussion</b>				
	Lochisen Punch Poinçon	<b>HP1</b>	375 + 550	0,07
	Schraubenschlüssel Wrench Clé à tube	<b>HW1</b>	375 + 550	0,11
	Schnellkupplung Quick Change Chuck Accouplement rapide	<b>5552</b>	375 + 550	0,16
	Füllschlauch orange (30 m) Orange Filler Tubing (30 m) Tuyau orange (30 m)	<b>30894</b>	375 + 550	0,36

## Bohrschablonen · Templets · Gabarits

Bestell-Nr. Order-No. No. de réf.	Bandbreite Belt Width Largeur de bande mm	Gewicht Weight Poids kg	Bestell-Nr. Order-No. No. de réf.	Bandbreite Belt Width Largeur de bande mm	Gewicht Weight Poids kg
<b>für/for/pour 375</b>			<b>für/for/pour 550</b>		
<b>375X-400</b>	400	0,84	<b>5-500</b>	500	1,05
<b>375X-500</b>	500	1,05	<b>5-650</b>	650	1,36
<b>375X-650</b>	650	1,36	<b>5-800</b>	800	1,68
<b>375X-800</b>	800	1,68	<b>5-1000</b>	1000	2,09
<b>375X-1000</b>	1000	2,09	<b>5-1200</b>	1200	2,51
<b>375X-1200</b>	1200	2,51	<b>5-1400</b>	1400	2,93
<b>375X-1400</b>	1400	2,93	<b>5-1600</b>	1600	3,35

## Bandschneider, Serie 400 Belt Cutter 400 Series Coupeuse de bande Série 400

<b>400430</b>	750	6,42
<b>400436</b>	900	7,32
<b>400442</b>	1050	8,59
<b>400448</b>	1200	8,62
<b>400460</b>	1500	10,43

## FLEXCO-LOK Band FLEXCO-LOK Tape Bande FLEXCO-LOK

Bestell-Nr. Order-No. No. de réf.	für for pour	Länge Length Longueur m	Gewicht Weight Poids kg
<b>FL7C</b>	375X/550	30	0,36

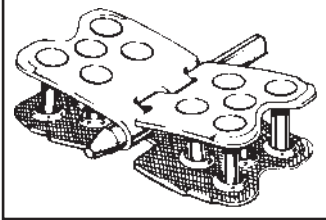

## FLEXCO Rivet Hinged (Scalloped Edge)

Transportband -  
Verbindungssystem  
für Bandstärken von  
5 bis 17 mm

Conveyor Belt Fastening  
System for Belts  
5 to 17 mm thick

Système d'agrafage pour  
bandes transporteuses  
d'épaisseur 5 - 17 mm

Verbindergroße Fastener Size Taille des agrafes	Für Transportbänder bis zu... N/mm Festigkeit For Belts with a Tensile Strength of up to... N/mm Pour bandes transporteuses à résistance de rupture jusqu'à... N/mm	empf. Bandstärkenbereich Belt Thickness Range Épaisseur de bandes recommandée mm	empf. kleinster Trommel-Ø rec. min. Pulley-Ø Ø tambour mini.rec. mm
<b>R2</b>	400	5 - 10	125
<b>R5</b>	800	6 - 11	200
<b>R5<sup>1/2</sup></b>	1250	9 - 15	250
<b>R6 / RAR6</b>	1400 / 1600	10 - 17	400
<b>R8 / RAR8</b>	2000 / 2500	10 - 17	400
<b>R9S</b>	3500	16 - 24	1050

**Inhalt:** Jeder Karton enthält 2 Verbinderstreifen für die angegebene Bandbreite. Nieten und Kupplungsstäbe extra bestellen.

**Content:** Each Box contains two Fastener Strips for the Belt Width specified. Order Rivets and Hinge Pins separately.

**Contenu:** Chaque boîte contient deux bandes d'agrafes pour la largeur de bande spécifiée. Veuillez commander rivets et axes séparément.

### Stahl verzinkt Galvanized Steel / Acier galvanisé

Bestell-Nr. Order-No. No. de réf.	Bandbreite Belt Width Largeur de Bande mm	Gewicht Weight Poids kg
<b>R2-20/500</b>	500	0,75
<b>R2-26/650</b>	650	0,97
<b>R2-32/800</b>	800	1,20
<b>R2-40/1000</b>	1000	1,50
<b>R2-48/1200</b>	1200	1,80
<b>R2-55/1400</b>	1400	2,00
<hr/>		
<b>R5-SE-20/500</b>	500	1,27
<b>R5-SE-26/650</b>	650	1,66
<b>R5-SE-32/800</b>	800	2,20
<b>R5-SE-40/1000</b>	1000	2,54
<b>R5-SE-48/1200</b>	1200	3,13
<b>R5-SE-55/1400</b>	1400	3,56
<b>R5-SE-63/1600</b>	1600	4,10
<hr/>		
<b>R5-<sup>1/2</sup>-SE-26/650</b>	650	2,40
<b>R5-<sup>1/2</sup>-SE-32/800</b>	800	2,95
<b>R5-<sup>1/2</sup>-SE-40/1000</b>	1000	3,68
<b>R5-<sup>1/2</sup>-SE-48/1200</b>	1200	4,49
<b>R5-<sup>1/2</sup>-SE-55/1400</b>	1400	5,16
<b>R5-<sup>1/2</sup>-SE-63/1600</b>	1600	5,89
<b>R5-<sup>1/2</sup>-SE-72/1800</b>	1800	6,63
<hr/>		
<b>R6-SE-32/800</b>	800	4,00
<b>R6-SE-40/1000</b>	1000	5,00
<b>R6-SE-48/1200</b>	1200	6,00
<b>R6-SE-55/1400</b>	1400	7,00
<b>R6-SE-63/1600</b>	1600	8,00
<b>R6-SE-72/1800</b>	1800	9,00
<hr/>		
<b>R8-SE-40/1000</b>	1000	5,00
<b>R8-SE-48/1200</b>	1200	6,00
<hr/>		
<b>MegAlloy</b>		
Bestell-Nr. Order-No. No. de réf.	Inhalt Content Contenu	Gewicht Weight Poids kg
<b>R2MA-SE</b>	10 × 170 mm	1,4
<b>R5MA-SE</b>	10 × 170 mm	2,2
<b>R5-<sup>1/2</sup>MA-SE</b>	10 × 170 mm	2,8

### Rostfrei W.1.4401 / AISI 316 / Z6CND17-11 Stainless / Inoxydable

Bestell-Nr. Order-No. No. de réf.	Bandbreite Belt Width Largeur de Bande mm	Gewicht Weight Poids kg
<b>R2S-20/500</b>	500	0,75
<b>R2S-26/650</b>	650	0,97
<b>R2S-32/800</b>	800	1,20
<b>R2S-40/1000</b>	1000	1,50
<b>R2S-48/1200</b>	1200	1,80
<hr/>		
<b>R5S-SE-20/500</b>	500	1,27
<b>R5S-SE-26/650</b>	650	1,66
<b>R5S-SE-32/800</b>	800	2,20
<b>R5S-SE-40/1000</b>	1000	2,54
<b>R5S-SE-48/1200</b>	1200	3,13
<b>R5S-SE-55/1400</b>	1400	3,56
<b>R5S-SE-63/1600</b>	1600	4,10
<hr/>		
<b>R9S-SE-48/1200</b>	1200	7,70
<b>R9S-SE-55/1400</b>	1400	9,00
<b>R9S-SE-63/1600</b>	1600	10,00
<b>R9S-SE-72/1800</b>	1800	11,50
<hr/>		
<b>RustAlloy - W.1.4016 / AISI 430 / Z8C17 magnetisch / magnetic / magnétique</b>		
<b>RAR5-SE-26/650</b>	650	1,66
<b>RAR5-SE-32/800</b>	800	2,20
<b>RAR5-SE-40/1000</b>	1000	2,54
<b>RAR5-SE-48/1200</b>	1200	3,13
<hr/>		
<b>RAR5-<sup>1/2</sup>-SE-26/650</b>	650	2,40
<b>RAR5-<sup>1/2</sup>-SE-32/800</b>	800	2,95
<b>RAR5-<sup>1/2</sup>-SE-40/1000</b>	1000	3,68
<b>RAR5-<sup>1/2</sup>-SE-48/1200</b>	1200	4,49
<b>RAR5-<sup>1/2</sup>-SE-55/1400</b>	1400	5,16
<hr/>		
<b>RAR6-SE-32/800</b>	800	4,00
<b>RAR6-SE-40/1000</b>	1000	5,00
<b>RAR6-SE-48/1200</b>	1200	6,00
<b>RAR6-SE-55/1400</b>	1400	7,00
<hr/>		
<b>RAR8-SE-40/1000</b>	1000	5,00
<b>RAR8-SE-48/1200</b>	1200	6,00

**Stahl / Steel / Acier**

Bestell-Nr. Order-No. No. de réf.	Ø mm	Verbinder Fasteners Agrafes	Bandbreite Belt Width Largeur de bande mm
<b>NC-500-1</b>	6,3	R2, R5, 375, 550	500
<b>NC-650-1</b>			650
<b>NC-800-1</b>			800
<b>NC-1000-1</b>			1000
<b>NC-1200-1</b>			1200
<b>NC-1400-1</b>			1400
<b>NC-1600-1</b>			1600
<b>NC-C</b>	Rolle / Coil / Rouleau 30 m		

<b>SC-500-1</b>	6,0	R2, R5, 375, 550	500
<b>SC-650-1</b>			650
<b>SC-800-1</b>			800
<b>SC-1000-1</b>			1000
<b>SC-1200-1</b>			1200
<b>SC-C</b>	Rolle / Coil / Rouleau 30 m		

<b>AC-500-1</b>	6,3	R2, R5, 375, 550	500
<b>AC-650-1</b>			650
<b>AC-800-1</b>			800
<b>AC-1000-1</b>			1000
<b>AC-1200-1</b>			1200
<b>AC-1400-1</b>			1400
<b>AC-1600-1</b>			1600
<b>AC-3000-1</b>			3000

<b>NAC-500-1</b>	6,3	R2, R5, 375, 550	500
<b>NAC-650-1</b>			650
<b>NAC-800-1</b>			800
<b>NAC-1000-1</b>			1000
<b>NAC-1200-1</b>			1200
<b>NAC-1400-1</b>			1400
<b>NAC-1600-1</b>			1600

<b>AC6-650-1</b>	9,6	R5-1/2, R6, R8	650
<b>AC6-800-1</b>			800
<b>AC6-1000-1</b>			1000
<b>AC6-1200-1</b>			1200
<b>AC6-1400-1</b>			1400
<b>AC6-1600-1</b>			1600
<b>AC6-1800-1</b>			1800

<b>NAC6-800-1</b>	10,3	R5-1/2, R6, R8	800
<b>NAC6-1000-1</b>			1000
<b>NAC6-1200-1</b>			1200
<b>NAC6-1400-1</b>			1400
<b>NAC6-1600-1</b>			1600
<b>NAC6-1800-1</b>			1800

<b>SC6-650-1</b>	8,8	R5-1/2, R6, R8	650
<b>SC6-800-1</b>			800
<b>SC6-1000-1</b>			1000
<b>SC6-1200-1</b>			1200
<b>SC6-1400-1</b>			1400
<b>SC6-1600-1</b>			1600

**Rostfrei / Stainless / Inoxydable**

Bestell-Nr. Order-No. No. de réf.	Ø mm	Verbinder Fasteners Agrafes	Bandbreite Belt Width Largeur de bande mm
<b>NCS-500-1</b>	6,3	R2, R5, 375, 550	500
<b>NCS-650-1</b>			650
<b>NCS-800-1</b>			800
<b>NCS-1000-1</b>			1000
<b>NCS-1200-1</b>			1200
<b>NCS-1400-1</b>			1400
<b>NCS-1600-1</b>			1600
<b>NCS-C</b>	Rolle / Coil / Rouleau 30 m		

<b>SSC-500-1</b>	6,0	R2, R5, 375, 550	500
<b>SSC-650-1</b>			650
<b>SSC-800-1</b>			800
<b>SSC-1000-1</b>			1000
<b>SSC-1200-1</b>			1200

<b>ACS-500-1</b>	6,3	R2, R5, 375, 550	500
<b>ACS-650-1</b>			650
<b>ACS-800-1</b>			800
<b>ACS-1000-1</b>			1000
<b>ACS-1200-1</b>			1200
<b>ACS-1400-1</b>			1400
<b>ACS-1600-1</b>			1600
<b>ACS-3000-1</b>			3000

<b>ACS6-650-1</b>	9,6	R5-1/2, R6, R8	650
<b>ACS6-800-1</b>			800
<b>ACS6-1000-1</b>			1000
<b>ACS6-1200-1</b>			1200
<b>ACS6-1400-1</b>			1400
<b>ACS6-1600-1</b>			1600
<b>ACS6-1800-1</b>			1800

<b>NCS962-1200-1</b>		R9	1200
<b>NCS962-1400-1</b>			1400
<b>NCS962-1600-1</b>			1600
<b>NCS962-1800-1</b>			1800

<b>NCS975-1200-1</b>		R9	1200
<b>NCS975-1400-1</b>			1400
<b>NCS975-1600-1</b>			1600
<b>NCS975-1800-1</b>			1800

**Antimagnetisch / Non magnetic  
Anti-magnétique**

<b>NB-500-1</b>	6,3	R2, R5, 375, 550	500
<b>NB-650-1</b>			650
<b>NB-800-1</b>			800
<b>NB-1000-1</b>			1000
<b>NB-1200-1</b>			1200

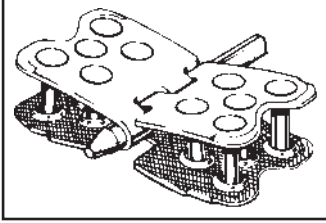

Selbstziehende Niete  
Self-setting Rivets  
Rivets auto-tirants

**Nieten Auswahltable**  
**Rivet Selection Chart**  
**Tableau de selection des rivets**

Verbinder Fasteners Agrafes	Bandstärke Belt Thickness Epaisseur de bande	Größe Size Largeur
<b>R2</b>	5 - 6	<b>SRAA</b>
	6 - 8	<b>SRA</b>
	7 - 10	<b>SRB</b>
<b>R5</b>	6 - 8	<b>SRA</b>
	7 - 10	<b>SRB</b>
	9 - 11	<b>SRC</b>
<b>R5-1/2</b>	8 - 9	<b>SRB</b>
	9 - 10,5	<b>SRC</b>
	10 - 12	<b>SRC/D</b>
	11 - 13,5	<b>SRD</b>
	13 - 15	<b>SRE</b>
<b>R6 / R8</b>	9 - 11	<b>SRC/D</b>
	10,5 - 13	<b>SRD</b>
	12 - 14	<b>SRE</b>
	13,5 - 16	<b>SRF</b>
	15 - 17	<b>SRG</b>
<b>R9S</b>	16,5 - 19	<b>SRH</b>
	18 - 21	<b>SRI</b>
	20 - 22	<b>SRJ</b>
	21 - 24	<b>SRK</b>

**FLEXCO Rapid Loader-Nieten · Rivets · Rivets**  
**Stahl / Steel / Acier**

Inhalt 60 Streifen / 1200 Niete pro Eimer  
Content 60 strips / 1200 rivets per bucket  
Contenu 60 bandes / 1200 rivets par seau

Bestell-Nr. Order-No. No. de réf.	Größe Size Taille	Farbe Colour Couleur	Gewicht Weight Poids kg
<b>CSRLA</b>	A	Rot/Red/Rouge	5,89
<b>CSRLB</b>	B	Weiß/White/Blanc	6,31
<b>CSRLC</b>	C	Blau/Blue/Bleu	6,72
<b>CSRLC/D</b>	C/D	Orange	7,05
<b>CSRLD</b>	D	Grün/Green/Vert	7,28
<b>CSRLE</b>	E	Lila/Purple/Lilas	7,53
<b>CSRLF</b>	F	Gelb/Yellow/Jaune	7,86
<b>CSRLG</b>	G	Schwarz/Black/Noir	8,11

**Rostfrei / Stainless / Inoxydable**

<b>CSRLA-S</b>	A	Rot/Red/Rouge	5,84
<b>CSRLB-S</b>	B	Weiß/White/Blanc	6,25
<b>CSRLC-S</b>	C	Blau/Blue/Bleu	6,76
<b>CSRLC/D-S</b>	C/D	Orange	6,94
<b>CSRLD-S</b>	D	Grün/Green/Vert	7,21
<b>CSRLE-S</b>	E	Lila/Purple/Lilas	7,47
<b>CSRLF-S</b>	F	Gelb/Yellow/Jaune	7,67
<b>CSRLG-S</b>	G	Schwarz/Black/Noir	7,94

**Nieten pro Verbindung**  
**Rivets per Splice**  
**Rivets par jonction**

Bandbreite Belt Width Largeur de bande	Platten Plates Plaques	R2	R5, 5-1/2, R6	R8/R9S
400	9	36	90	
500	11	44	110	
650	14	56	140	
800	17	68	170	
1000	22	88	220	352
1200	27	108	270	432
1400	31	124	310	496
1600	36	144	360	576
1800	41	164	410	656

**FLEXCO-Nieten · Rivets · Rivets**  
**Stahl / Steel / Acier**

Bestell-Nr. Order-No. No. de réf.	Größe Size Largeur	Inhalt Content Contenu	Gewicht Weight Poids kg
<b>SRAA</b>	SRAA	250	1,00
<b>SRA</b>	SRA	250	1,04
<b>SRB</b>	SRB	250	1,13
<b>SRC</b>	SRC	250	1,18
<b>SRC/D</b>	SRC/D	250	1,27
<b>SRD</b>	SRD	250	1,32
<b>SRE</b>	SRE	250	1,41
<b>SRF</b>	SRF	250	1,41
<b>SRG</b>	SRG	250	1,45
<b>SRH</b>	SRH	250	1,54
<b>SRI</b>	SRI	250	1,65
<b>SRJ</b>	SRJ	250	1,73
<b>SRK</b>	SRK	250	1,85

<b>SRA-2M</b>	SRA	2000	7,52
<b>SRB-2M</b>	SRB	2000	8,20
<b>SRC-2M</b>	SRC	2000	9,15
<b>SRC/D-2M</b>	SRC/D	2000	9,60
<b>SRD-2M</b>	SRD	2000	9,92
<b>SRE-2M</b>	SRE	2000	10,46
<b>SRF-2M</b>	SRF	2000	11,05
<b>SRG-2M</b>	SRG	2000	11,28

**Rostfrei W.1.4016 / magnetisch**  
**Stainless AISI 430 / magnetic**  
**Inoxydable Z8C17 / magnétique**

<b>SRAA-S</b>	SRAA	250	1,00
<b>SRA-S</b>	SRA	250	1,04
<b>SRB-S</b>	SRB	250	1,13
<b>SRC-S</b>	SRC	250	1,18
<b>SRC/D-S</b>	SRC/D	250	1,27
<b>SRD-S</b>	SRD	250	1,32
<b>SRE-S</b>	SRE	250	1,41
<b>SRF-S</b>	SRF	250	1,41
<b>SRG-S</b>	SRG	250	1,45



# FLEXCO Rivet Hinged (Scalloped Edge)

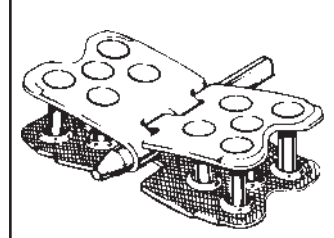

Montagegeräte

Installation Tools

Outilsage de montage

Bestell-Nr. Order-No. No. de réf.	Breite Width Largeur mm	Gewicht Weight Poids kg
<b>MSRTX-30</b>	750	23,00
<b>MSRTX-36</b>	900	25,00
<b>MSRTX-42</b>	1050	27,00
<b>MSRTX-48</b>	1200	29,00
<b>MSRTX-60</b>	1500	31,00
<b>MSRT-30E*</b>	750	39,00
<b>MSRT-36E*</b>	900	44,00
<b>MSRT-42E*</b>	1050	49,00
<b>MSRT-48E*</b>	1200	54,00
<b>MSRT-60E*</b>	1500	71,00
<b>MSRT-72</b>	1800	46,00
<b>MSRT8-48</b>	1200	38,50
<b>MSRT8-60</b>	1500	42,00
<b>MSRT8-48E*</b>	1200	54,00
<b>MSRT8-60E*</b>	1500	69,00
<b>MSRT9-48</b>	1200	40,00
<b>MSRT9-60</b>	1500	42,00
<b>MSRT9-72</b>	1800	45,00
<b>MSRT9-84</b>	2100	50,00

\*mit Metallkoffer / with Tool Box / avec coffret métallique

## ExtraMetallkoffer

### Extra Tool Box

### Coffret métallique supplémentaire

<b>TB900</b>	17,50
<b>TB1200</b>	18,50
<b>TB1500</b>	22,50

Bestell-Nr. Order-No. No. de réf.	Breite Width Largeur mm	Gewicht Weight Poids kg
<b>R2T</b>	300	3,00

## Montagegeräte / Installation Tools / Outillage de montage

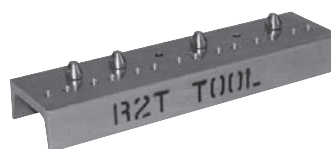
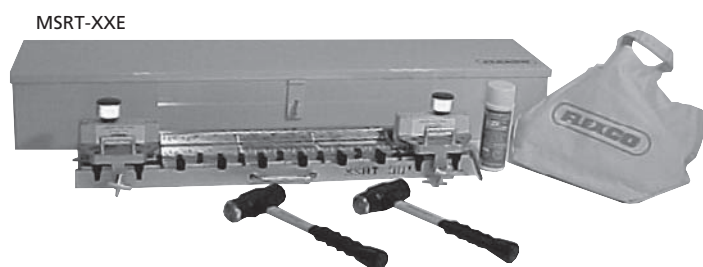
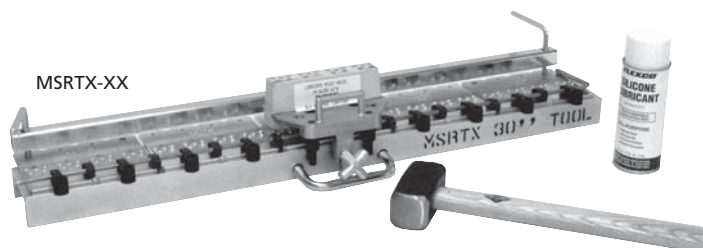

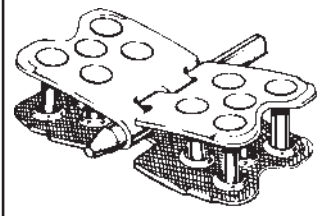

## FLESCO Rivet Hinged (Scalloped Edge)

Ersatzteile  
und Zubehör

Spare Parts and  
Accessories

Pièces de rechange  
et accessoires

Bestell-Nr. Order-No. No. de réf.		Gewicht Weight Poids kg	Bestell-Nr. Order-No. No. de réf.		Gewicht Weight Poids kg
<b>SR700</b>	Führungsblock/Guide Block/Bloc de guidage R5, R 5½, R6	1,36	<b>SR24</b>	Halterung/Gauge Pin Guide/Fixation	0,04
<b>SR800</b>	Führungsblock/Guide Block/Bloc de guidage R8, R9S	1,36	<b>SR25</b>	Halterung/Gauge Pin Guide/Fixation	0,04
<b>SR759</b>	Nietentreiber/Drive Rod/Chassoir de rivets R5, R 5½, R6	0,44	<b>SR22A</b>	Amboßplatte komplett/Anvil Plate complète Plaque d'enclume complète	0,80
<b>SR759-2</b>	Nietentreiber/Drive Rod/Chassoir de rivets R2	0,40	<b>SR23</b>	Fixierschraube komplett/Tightening Bolt complete Vis de fixation complète	0,10
<b>SR859-8</b>	Nietentreiber/Drive Rod/Chassoir de rivets R8, R9S	0,50	<b>SR757</b>	Fixierschraube/Clamping Screw/Vis de fixation	0,25
<b>4FH</b>	Hammer/Hammer/Marteau	2,00	<b>SR747</b>	Nietenführungseinheit Rivet Guide Locator Assembly Unité de guidage de rivets	0,10
<b>SL5-1</b>	Silikonspray/Silicone Spray/Silicone	0,62	<b>BRPS</b>	Schrauben / Screws / Vis (50)	0,31
<b>SR50</b>	Einzelnietentreiber komplett Individual Drive Rod complete Chassoir pour rivets individuels complet	0,35	<b>SR5-1</b>	Schraubhülsen 2er-Set / Collets Set of 2 Douilles jeu de 2	0,04
<b>SR5-7</b>	Treiberstift/Drive Pin/Tige de chassoir	0,03	<b>SR2-30</b>	Steckstift für / Gauge Pin for / Goupille pour MSRT-30 / MSRTX-30	
<b>SR-CB</b>	Kanvastasche/Canvas Bag/Poche de canevas	0,60	<b>SR2-36</b>	MSRT-36 / MSRTX-36	
			<b>SR2-42</b>	MSRT-42 / MSRTX-42	
			<b>SR2-48</b>	MSRT-48 / MSRTX-48	
			<b>SR2-60</b>	MSRT-60 / MSRTX-60	
			<b>SR2-72</b>	MSRT-72 / MSRTX-72	
			<b>SR2-84</b>	MSRT-84 / MSRTX-84	
			<b>SR9-30</b>	Klemmschiene für/Clamp Bar for/Dispositif de serrage pour MSRT-30 / MSRTX-30	
			<b>SR9-36</b>	MSRT-36 / MSRTX-36	
			<b>SR9-42</b>	MSRT-42 / MSRTX-42	
			<b>SR9-48</b>	MSRT-48 / MSRTX-48	
			<b>SR9-60</b>	MSRT-60 / MSRTX-60	
			<b>SR9-72</b>	MSRT-72 / MSRTX-72	
			<b>SR9-84</b>	MSRT-84 / MSRTX-84	

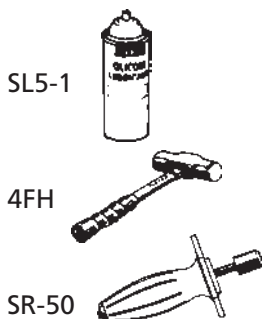

SR759 (R5 / R5½ / R6)  
SR759-2 (R2)  
SR759-8 (R8 / R9)

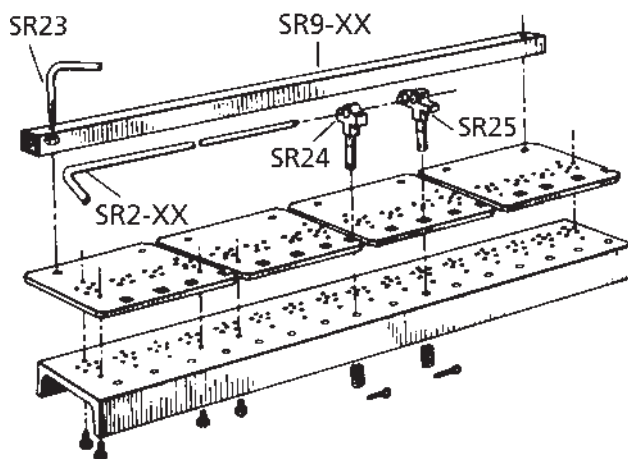
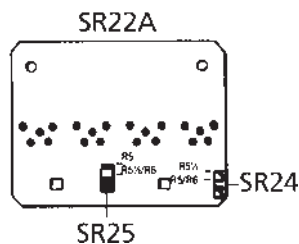
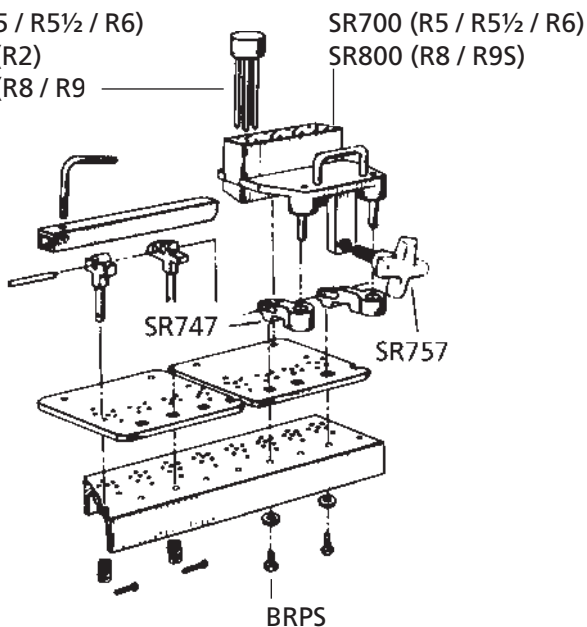

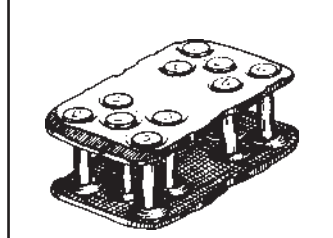

## FLEXCO Rivet Solid Plate

Transportband -  
Verbindungssystem für  
Bandstärken  
von 6 bis 24 mm

Conveyor Belt Fastening  
System for Belts  
6 to 24 mm thick

Système d'agrafage pour  
bandes transporteuses  
d'épaisseur 6 - 24 mm

Verbindergroße Fastener Size Taille des agrafes	Inhalt Content Contenu	Für Transportbänder bis zu... N/mm Festigkeit For Belts with a Tensile Strength of up to... N/mm Pour bandes transporteuses à résistance de rupture jusqu'à... N/mm	empf. Bandstärkenbereich Belt Thickness Range Épaisseur de bandes recommandée mm	empf. kleinster Trommel-Ø rec. min. Pulley-Ø Ø tambour mini.rec. mm
<b>BR-10</b>	1,5 m	1250	6 - 17	450
<b>BR-14</b>	1,5 m	1600	10 - 24	900

### Montagegeräte · Installation Tools Outillage de montage

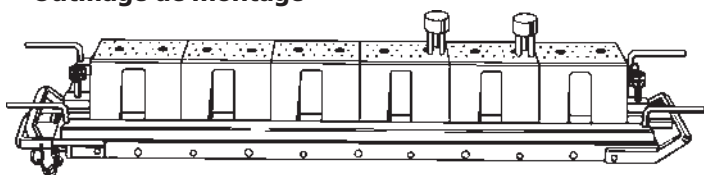

Bestell-Nr. Order-No. No. de réf.	Breite Width Largeur mm	Gewicht Weight Poids kg
<b>MBRTA-42*</b>	1050	66,5
<b>MBRTA-48*</b>	1200	76,0
<b>MBRTA-60*</b>	1500	95,0
<b>MBRTA-72</b>	1800	87,0
<b>MBRTA-84</b>	2100	102,0
<b>MBRTA-96</b>	2400	116,0
<b>MBRTX-42</b>	1050	42,0
<b>MBRTX-48</b>	1200	48,0

\* mit Metallkoffer · with Tool Box · avec coffret métallique

### Verbinder · Fasteners · Agrafes

Material Material Matériel	Bestell-Nr. Order-No. No. de réf.	Inhalt Content Contenu m	Gewicht Weight Poids kg
Stahl · Steel Acier	<b>BR-10</b>	1,5	3,63
	<b>BR-14</b>	1,5	5,86
MegAlloy	<b>BR-10MA</b>	1,5	3,63
	<b>BR-14MA</b>	1,5	5,86
Rostfrei · Stainless Inoxydable	<b>BR-10S</b>	1,5	3,63

### Ersatzteile und Zubehör Spare Parts and Accessories Pièces de rechange et accessoires

Bestell-Nr. Order-No. No. de réf.	Gewicht Weight Poids kg
<b>BR500D</b>	1,36
<b>BR151</b>	0,23

### Nieten Auswahltable Rivet Selection Chart Tableau de selection des rivets

Verbinder Fasteners Agrafes	Bandstärke Belt Thickness Épaisseur de bande	Größe Size Largeur
<b>BR-10</b>	6 - 8	<b>SRA</b>
	7 - 10	<b>SRB</b>
	9 - 11	<b>SRC</b>
	10 - 13	<b>SRC/D</b>
	12 - 14	<b>SRD</b>
	13 - 16	<b>SRE</b>
<b>BR-14</b>	15 - 17	<b>SRF</b>
	10 - 13	<b>SRD</b>
	12 - 14	<b>SRE</b>
	13 - 16	<b>SRF</b>
	15 - 17	<b>SRG</b>
	16 - 19	<b>SRH</b>
	18 - 21	<b>SRI</b>
	20 - 22	<b>SRJ</b>
21 - 24	<b>SRK</b>	

### Nieten pro Verbindung Rivets per Splice Rivets par jonction

Bandbreite Belt Width Largeur de bande	BR-10	BR-14
400	90	126
500	110	154
650	140	196
800	170	238
1000	220	308
1200	270	378
1400	310	434
1600	360	504
1800	410	574

Preise der Nieten siehe Seite 16

Prices of rivets on page 16

Prix de rivets sur la page 16

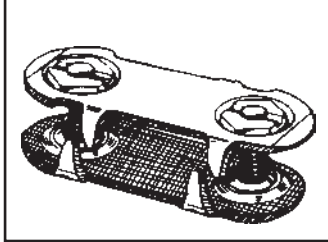

## FLEXCO Bolt Solid Plate

Transportband -  
Verbindungssystem für  
Bandstärken  
von 5 bis 30 mm

Conveyor Belt Fastening  
System for Belts  
5 to 30 mm thick

Système d'agrafage pour  
bandes transporteuses  
d'épaisseur 5 - 30 mm

Verbindergroße Fastener Size Taille des agrafes	Für Transportbänder bis zu... N/mm Festigkeit For Belts with a Tensile Strength of up to... N/mm Pour bandes tranporteuses à résistance de rupture jusqu'à... N/mm	empf. Bandstärkenbereich Belt Thickness Range Épaisseur de bandes recommandée mm	empf. kleinster Trommel-Ø rec. min. Pulley-Ø Ø tambour mini.rec. mm
<b>1</b>	315	5 - 11	250
<b>140</b>	400	5 - 11	300
<b>190</b>	630	8 - 14	400
<b>1-1/2</b>	500	11 - 17	400
<b>2</b>	800	14 - 21	700
<b>2-1/4</b>	1000	14 - 30	850
<b>2-1/2</b>	800	19 - 25	1000
<b>3</b>	1000	24 +	1200

Bestell-Nr. Order-No. No. de réf.	Inhalt Content Contenu	Gewicht Weight Poids kg	Bestell-Nr. Order-No. No. de réf.	Inhalt Content Contenu	Gewicht Weight Poids kg
---	------------------------------	----------------------------------	---	------------------------------	----------------------------------

### E-Stahl / Steel / Acier

<b>1E</b>	25	1,32
<b>140E</b>	25	2,08
<b>190E</b>	25	2,17
<b>1-1/2E</b>	25	2,68
<b>2E</b>	25	3,63
<b>2-1/4E</b>	25	4,89
<b>2-1/2E</b>	10	2,90
<b>3</b>	10	3,18

### C-Stahl / Steel / Acier

<b>1C</b>	100	4,94
<b>140C</b>	100	7,12
<b>190C</b>	100	8,39
<b>1-1/2C</b>	100	9,93
<b>2C</b>	100	13,74
<b>2-1/4C</b>	100	19,18
<b>2-1/2C</b>	100	29,03
<b>3C</b>	100	31,29

### E-MegAlloy Oberplatten/Top Plates/plaquettes supérieures

<b>140EMA</b>	25	2,08
<b>190EMA</b>	25	2,17
<b>1-1/2EMA</b>	25	2,68
<b>2EMA</b>	25	3,63

### C-MegAlloy

<b>140CMA</b>	100	7,12
<b>190CMA</b>	100	8,39
<b>1-1/2CMA</b>	100	9,93
<b>2CMA</b>	100	13,74

### E-Rostfrei / Stainless / Inoxydable

<b>140ES</b>	25	2,08
<b>190ES</b>	25	2,17
<b>1-1/2ES</b>	25	2,68
<b>2ES</b>	25	3,63

**Reparatur-Set** Eimer mit 50 Verbindern, HP1, HW1, 110  
und ca. 5 m LOK-Band

**Repair Set** Bucket containing 50 fasteners, HP1, HW1, 110  
and approx. 5 m LOK Tape

### E-Everdur

<b>140EE</b>	25	2,08
<b>190EE</b>	25	2,17
<b>1-1/2EE</b>	25	2,68
<b>2EE</b>	25	3,63

**Jeu de réparation** Seau avec 50 agrafes, HP1, HW1, 110  
et env. 5 m de bande LOK

**FVS 140** 6,24  
**FVS 190** 6,51

### VP-Vulcanized Plate

Bestell-Nr. Order-No. No. de réf.	Bandbreite Belt Width Largeur de bande mm	Gewicht Weight Poids kg
<b>140VP</b>	900 (5 X 180 mm)	2,48
<b>190VP</b>	900 (5 X 180 mm)	2,62
<b>2VP</b>	900 (5 X 180 mm)	3,58

### Platten pro Verbindung Fasteners per Splice Plaquettes par jonction

Bandbreite Belt Width Largeur de bande mm	Größe Size Taille		Größe Size Taille		Größe Size Taille	
	1, 90°	140, 45°	190, 90°	2, 45°	2-1/4, 90°	3, 45°
400	13	19	10	15	8	12
500	16	26	13	21	10	16
650	21	33	17	27	14	21
800	26	40	21	32	17	26
1000	32	45	26	36	21	29
1200	39	54	31	43	26	35
1400	46	71	37	51	30	40

## Rißreparaturverbinder · Rip Repair Fasteners · Agrafes pour réparation de déchirure

Bestell-Nr. Order-No. No. de réf.	Inhalt Content Contenu	Gewicht Weight Poids kg	Bestell-Nr. Order-No. No. de réf.	Inhalt Content Contenu	Gewicht Weight Poids kg
<b>Stahl / Steel / Acier</b>			<b>Rostfrei / Stainless / Inoxydable</b>		
<b>RP1E</b>	25	2,14	<b>RP1ES</b>	25	2,24
<b>RP2E</b>	25	4,64	<b>RP2ES</b>	25	4,57
<b>16</b>	50	1,96			



**Sechszackverbinder**  
**Programmübersicht ANKER/Seite 19**  
**Six Point Fasteners**  
**Program Overview ANKER/Page 19**  
**Agrafes à griffes**  
**Gamme de produits ANKER/Page 19**

## Bohrschablonen · Templets · Gabarits

Bestell-Nr. Order-No. No. de réf.	Bestell-Nr. Order-No. No. de réf.	Bestell-Nr. Order-No. No. de réf.	Bandbreite Belt Width Largeur de bande mm	Gewicht Weight Poids kg
<b>1-400</b>			400	0,8
<b>1-500</b>	<b>140-500</b>	<b>190-500</b>	500	1,0
<b>1-650</b>	<b>140-650</b>	<b>190-650</b>	650	1,3
<b>1-800</b>	<b>140-800</b>	<b>190-800</b>	800	1,6
<b>1-1000</b>	<b>140-1000</b>	<b>190-1000</b>	1000	2,0
<b>1-1200</b>	<b>140-1200</b>	<b>190-1200</b>	1200	2,4
<b>1-1400</b>	<b>140-1400</b>	<b>190-1400</b>	1400	2,8
<b>1-1/2-500</b>			500	1,0
<b>1-1/2-650</b>			650	1,3
<b>1-1/2-800</b>	<b>2-800</b>		800	1,6
<b>1-1/2-1000</b>	<b>2-1000</b>		1000	2,0
<b>1-1/2-1200</b>	<b>2-1200</b>		1200	2,4
<b>1-1/2-1400</b>	<b>2-1400</b>		1400	2,8
<b>2-1/4-800</b>	<b>2-1/2-800</b>	<b>3-800</b>	800	1,6
<b>2-1/4-1000</b>	<b>2-1/2-1000</b>	<b>3-1000</b>	1000	2,0
<b>2-1/4-1200</b>	<b>2-1/2-1200</b>	<b>3-1200</b>	1200	2,4
<b>2-1/4-1400</b>	<b>2-1/2-1400</b>	<b>3-1400</b>	1400	2,8

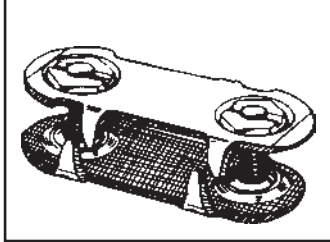

**Montagewerkzeuge  
für FLEXCO  
Bolt Solid Plate**

**Installation Tools  
for FLEXCO  
Bolt Solid Plate**

**Outillage de montage  
pour FLEXCO  
Bolt Solid Plate**

		Bestell-Nr. Order-No. No. de réf.	Verbindergroße Fastener Size Taille d'agrafe	Gewicht Weight Poids kg
<b>Manuelle Montage · Hand Tools · Montage manuel</b>				
	Schraubenbrecher	<b>110</b>	1, 140, 190, RP1, 375X, 550	0,60
	Bolt Breaker	<b>112</b>	1-1/2, 2, 2-1/4, RP2	0,
	Casse-vis	<b>113</b>	2-1/2, 3	0,90
	Locheisen	<b>P1P</b>	1, 140, 190, RP1, 375X, 550	0,06
	Punch	<b>P2P</b>	1-1/2, 2, 2-1/4, RP2	0,10
	Poinçon	<b>P3P</b>	2-1/2, 3	0,13
	Steckschlüssel	<b>S1S</b>	1, 140, 190, RP1, 375X, 550	0,09
	Wrench	<b>S2S</b>	1-1/2, 2, 2-1/4, RP2	0,09
	Clé à tube	<b>S3S</b>	2-1/2, 3	0,11
	Schraubenhorn Bolthorn Corne à vis	<b>2BH</b>		0,02
	Meißel	<b>C1C</b>	1, 140, 190, RP1, 375X, 550	0,54
	Cracking Chisel Burin	<b>C2C</b>	1-1/2, 2, 2-1/4, RP2	0,54
<b>Für Schlagschrauber · Power Tools · Outils pour boulonneuse à percussion</b>				
	Locheisen	<b>HP1</b>	1, 140, 190, RP1, 375X, 550	0,07
	Punch	<b>HP2</b>	1-1/2, 2, 2-1/4, RP2	0,07
	Poinçon	<b>HP3</b>	2-1/2, 3	0,10
	Steckschlüssel	<b>HW1</b>	1, 140, 190, RP1, 375X, 550	0,11
	Wrench	<b>HW2</b>	1-1/2, 2, 2-1/4, RP2	0,14
	Clé à tube	<b>HW3</b>	2-1/2, 3	0,17
	Schnellkupplung Quick Change Chuck Accouplement rapide	<b>5552</b>	für HP + HW Werkzeuge for HP + HW Tools pour Outillage HP + HW	0,16
<b>FLEXCO-LOK Band · FLEXCO-LOK Tape · Bande FLEXCO-LOK</b>				
	Bestell-Nr. Order-No. No. de réf.	für for pour	Länge Length Longueur m	Gewicht Weight Poids kg
	<b>FL7C</b>	1, 140	30	0,36
<b>FL11C</b>	190, 1-1/2, 2, 2-1/4, 2-1/2, 3	30	0,45	
	<b>Makita Schlagschrauber Nr. 6905H Preis auf Anfrage</b>	<b>Makita Impact Tool Nr. 6905H Price on demand</b>	<b>Boulonneuse Makita n° 6905H Prix sur demande</b>	

## Extra Schrauben und Muttern

## Extra Bolts and Nuts

## Vis et écrous supplémentaires

### Extra Schrauben Extra Bolts Vis supplémentaires

#### Stahl / Steel / Acier

Bestell-Nr. Order-No. No. de réf.	Verbindergröße Fastener Size Taille des agrafes	Gewicht Weight Poids kg
<b>20391</b>	1	0,80
<b>20398</b>	RP1, 375X	1,10
<b>20399</b>	140, 190, 550	1,00
<b>20402</b>	1-1/2	1,50
<b>20406</b>	2, RP2	1,80
<b>20410</b>	2-1/4	2,20
<b>20414</b>	2-1/2, 3	3,40

#### Rostfrei / Stainless / Inoxydable

<b>20400</b>	140, 190, 375X, 550, RP1	1,50
<b>20407</b>	1-1/2, 2, RP2	1,80
<b>20411</b>	2-1/4	2,20

#### Everdur

<b>20397</b>	1	0,84
<b>20409</b>	1-1/2, 2, RP2	1,68

### Locheisensatz / Belt Punch Set / Jeu de poinçons

Bestell-Nr. Order-No. No. de réf. (6 - 24 mm)	Gewicht Weight Poids kg
<b>LS-1/06-24</b>	1,36

### Locheisen einzeln / Belt Punch Spares / Poinçon de rechange

Bestell-Nr. Order-No. No. de réf. (6 - 24 mm)	Gewicht Weight Poids kg
<b>L-06 - L-10</b>	0,06
<b>L-12 - L-16</b>	0,12
<b>L-18 - L-24</b>	0,18

### Extra Muttern Extra Nuts Écrous supplémentaires

#### Stahl / Steel / Acier

Bestell-Nr. Order-No. No. de réf.	Verbindergröße Fastener Size Taille des agrafes	Gewicht Weight Poids kg
<b>20377</b>	1, 140, 190, RP1 + 375X, 550	0,30
<b>20378</b>	1-1/2, 2, 2-1/4, RP2	0,50
<b>20379</b>	2-1/2, 3	1,00

#### Rostfrei / Stainless / Inoxydable

<b>20381</b>	1, 140, 190, RP1 + 375X, 550	0,30
<b>20382</b>	1-1/2, 2, 2-1/4, RP2	0,50

#### Everdur

<b>20387</b>	1, 140, 190, RP1 + 375X	0,30
<b>20388</b>	1-1/2, 2, 2-1/4, RP2	0,50



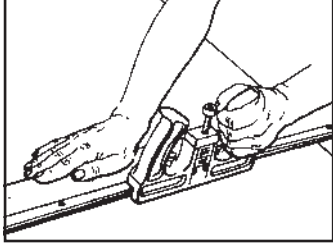

**ALLIGATOR/FLEXCO**  
Bandschneider und  
Bandspanner

**ALLIGATOR/FLEXCO**  
Belt Cutters and  
Belt Clamps

**ALLIGATOR/FLEXCO**  
Coupeuses de bande  
et pinceurs de bande

		Bestell-Nr. Order-No. No. de réf.	Breite Width Largeur mm	Gewicht Weight Poids kg	
<p>Bandschneider Belt Cutter Coupeuse de bande</p>		<b>300324</b>	600	8,00	
		<b>300330</b>	750	8,70	
		<b>300336</b>	900	9,00	
		<b>300342</b>	1050	11,80	
		<b>300348</b>	1200	12,70	
		<b>300360</b>	1500	14,90	
		<b>300372</b>	1800	17,00	
		<b>30023</b> <b>300</b>	Klinge/Blade/Lame Griff/Handle/Manche		0,10 1,10
<p>Bandschneider Belt Cutter Coupeuse de bande</p> <p><b>840</b> 10 - 20 mm <b>845LD</b> - 12 mm</p>		<b>840836/845836LD</b>	900	12,00	
		<b>840848/845848LD</b>	1200	14,00	
		<b>840860/845860LD</b>	1500	17,00	
		<b>840872/845872LD</b>	1800	19,00	
		<b>840884/845884LD</b>	2100	22,00	
		<b>840WA</b>	Griff/Handle/Manche		1,27
		<b>840SD</b>	Rechtw. Anschlagschiene Squaring device Rail fixe rectangulaire		0,10
		<b>820/840-1CB</b> <b>845-CBK</b>	Klinge/Blade/Lame Klinge/Blade/Lame		0,10 0,10
<p>Bandhobel Belt Skiver Rabot pour bande</p>		<b>FSK-1</b>	31995	9,30	
		<b>FSK-1B</b>	31996	Klinge/Blade/Lame 0,10	
<p>Bandspannsysteme Far-Pull Belt Clamps Pinceur de bande</p> <p>mit 4 Klemmbalken und 4 Klemmen</p> <p>with 4 clamp bars and 4 scissors</p> <p>avec 4 barres et 4 pinces</p>		<b>LSHD30/750</b>	750	29,50	
		<b>LSHD36/900</b>	900	32,50	
		<b>LSHD42/1050</b>	1050	35,00	
		<b>LSHD48/1200</b>	1200	39,00	
		<b>LSHD60/1500</b>	1500	44,00	
		<b>LSHD72/1800</b>	1800	48,00	
		<b>LSHDB30/750</b>	750	9,00	
		<b>LSHDB36/900</b>	900	10,50	
	<b>LSHDB42/1050</b>	1050	12,00		
	<b>LSHDB48/1200</b>	1200	13,50		
	<b>LSHDB60/1500</b>	1500	16,50		
	<b>LSHDB72/1800</b>	1800	18,00		
	<b>LSHDS</b>	Klemme / Scissors / Pince		2,75	



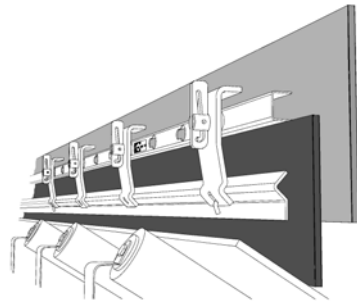

Seitenabdichtungssystem  
Conveyor Skirt Clamp  
Système latéral d'étanchéité

Bestell-Nr.  
Order-No.  
No. de réf.

EDV-Nr.  
Item-No.  
No. inf.

Breite  
Width  
Largeur  
mm

Gewicht  
Weight  
Poids  
kg

**FLSC-1**  
**FL-RPI**  
**FL-PC**  
**FL-CP**  
**FL-RBI**

71052  
71058  
71057  
71056  
71060

1800

15,00  
2,70  
0,90  
0,30  
4,10

Förderbandzentrierstationen  
Conveyor Belt Positioner  
Station de centrage pour  
bandes transporteuses



mit Exalon Rollen  
with Exalon Rollers  
avec rouleaux exalone

mit Stahl Rollen  
with Steel Rollers  
avec rouleaux en acier

**RBP1E-S**  
**RBP1E-M**  
**RBP1E-L**  
**RBP1E-XL**

**RBP1S-S**  
**RBP1S-M**  
**RBP1S-L**  
**RBP1S-XL**

Bestell-Nr.  
Order-No.  
No. de réf.

Gewicht  
Weight  
Poids  
kg



Kupplungsstabschneider  
Hinge Pin Cutter  
Pince à couper  
les axes de jonction

**APC-1**

0,23



Bandeckentrimnzange  
Belt Nippers  
Pince à rogner

**BN-1**

0,36



Rillenhobel  
Hand Skiver  
Rabot pour courroie

**RTBS-F**

0,06

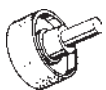

Bandschleifer  
Belt Grinder  
Meule pour bande

**RB-1**

0,34



Bandhalter (Paar)  
Belt Grip (Pair)  
Poignée pour bande (Jeux)

**22**

1,13



Bandkehrer  
Belt Grover  
Rabot pour bande

**FBG1**  
**HSP3**

0,82  
0,02



Silikon Spray  
Silicon Spray  
Silicone

**SL5-1**

0,62

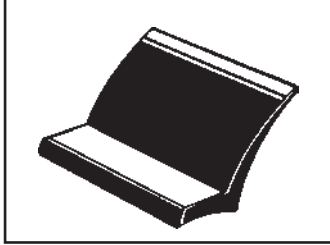

## TATCH A CLEAT

Schraubstollen und  
Führungsprofile

Mechanical Belt  
Cleats and Guides

Profils à vis et de  
guidage

**Hinweis:**  
Weitere Informationen  
finden Sie in unserer  
Broschüre TAC 100.

**Notice:**  
For further Information see  
our Brochure TAC 100.

**Renvoi:**  
Pour d'autres informations  
veuillez consulter notre  
brochure TAC 100.

Tatch-A-Cleat	Zusammensetzung Compound Composition	Min. Trommel-Ø Min. Pulley-Ø Ø tambour mini mm	Temperatur- einsatzbereich Temperature Service Range Température Rayon d'action	Abriebbeständigkeit Abrasion Resistance Résistance à l'abrasion	Ölbeständigkeit Oil Resistance Résistance à l'huile	Säurebeständigkeit Acid Resistance Résistance aux acides
<b>L</b>	Weiß/Schwarz Nitril - FDA White/Black Nitril - FDA blanc/noir nitril - FDA	50	-40° bis / up to / jusqu'à + 110° C	+	++	+
<b>EC</b>	Schwarz EPDM Black EPDM noir EPDM	EC1-3: 75 EC4: 100 EC6: 150	-55° bis / up to / jusqu'à + 150° C	++	N/A	++
<b>HD</b>	Schwarz SBR Black SBR noir SBR	75	-40° bis / up to / jusqu'à + 80° C	++	N/A	0
<b>LUG/PEG</b>	Tan Isopren FDA Tan Isoprene FDA tan isoprène FDA	80	-40° bis / up to / jusqu'à + 80° C	++	N/A	+
<b>GUIDE</b>	Schwarz Neopren Black Neoprene noir neoprène	A: 100 B: 150 C: 200	-40° bis / up to / jusqu'à + 110° C	+	+	+

### HD Profile Cleats Profils

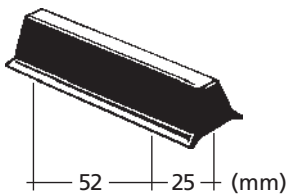





	Bestell-Nr. Order-No. No. de Réf.	Höhe Height Hauteur mm	Inhalt Content Contenu	Gewicht Weight Poids kg	
Schwarz, verzinkte Schrauben Black, plated Fasteners Noir, vis galvanisées	<b>HD-1</b> <b>HD-2</b>	25 50	10X610 mm 5X610 mm	5,22 4,30	
Schwarz, rostfreie Schrauben Black, stainless Fasteners Noir, vis inoxydables	<b>HD-1S</b> <b>HD-2S</b>	25 50	10X610 mm 5X610 mm	5,35 4,30	
<b>Extra Schrauben und Unterlegscheiben Extra Bolts and Washers Vis et rondelles supplémentaires</b>	verzinkt, plated, galvanisées	<b>HD1-F (D)</b> <b>HD2-F (D)</b>	25 32,5	125 125	1,24 1,50
	rostfrei, stainless, inoxydables	<b>HD1-FS (D)</b> <b>HD2-FS (D)</b>	25 32,5	125 125	1,24 1,50

### EC Profile Cleats Profils

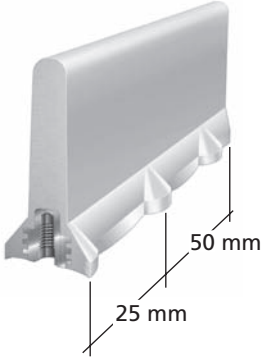

Schwarz, verzinkte Schrauben Black, plated Fasteners Noir, vis galvanisées	<b>EC1-1/4</b> <b>EC2</b> <b>EC3</b> <b>EC4</b> <b>EC6</b>	32 51 76 102 152	5X1220 mm 2X1220 mm	5,67 7,03 9,98 14,97 12,84
--	--	------------------------------	------------------------	--

<b>Extra Schrauben Extra Bolts Vis supplémentaires</b>	verzinkt, plated, galvanisées	<b>ECF</b> <b>EC4F</b> <b>EC6F</b> <b>ECFS</b>	61 61 33 61	1,27 1,50 0,91 1,32
	rostfrei, stainless, inoxydables			

		Bestell-Nr. Order-No. No. de réf.	Höhe Height Hauteur mm	Inhalt Content Contenu	Gewicht Weight Poids kg	
 <b>Profile Cleats Profils</b> 	Schwarz, verzinkte Schrauben Black, plated Fasteners Noir, vis galvanisées	<b>L5/8-B</b> <b>L1-B</b> <b>L1-1/2-B</b> <b>L2-B</b> <b>L3-B</b>	16 25 38 54 76	10X610 mm	3,31 4,22 5,08 6,35 8,31	
	Schwarz, rostfreie Schrauben Black, stainless Fasteners Noir, vis inoxydables	<b>L5/8-BS</b> <b>L1-BS</b> <b>L1-1/2-BS</b> <b>L2-BS</b> <b>L3-BS</b>	16 25 38 54 76	10X610 mm	3,31 4,22 5,08 6,35 8,31	
	Weiß, verzinkte Schrauben White, plated Fasteners Blanc, vis galvanisées	<b>L5/8-W</b> <b>L1-W</b> <b>L1-1/2-W</b> <b>L2-W</b> <b>L3-W</b>	16 25 38 54 76	10X610 mm	3,31 4,22 5,58 6,58 8,75	
	Weiß, rostfreie Schrauben White, stainless Fasteners Blanc, vis inoxydables	<b>L5/8-WS</b> <b>L1-WS</b> <b>L1-1/2-WS</b> <b>L2-WS</b> <b>L3-WS</b>	16 25 38 54 76	10X610 mm	3,31 4,22 5,58 6,58 8,75	
	<b>Extra Schrauben und Unterlegscheiben für L/LUG/PEG</b> <b>Extra Bolts and Washers for L/LUG/PEG</b>	verzinkt plated galvanisées	<b>L1/2-F</b> <b>L5/8-F</b> <b>L3/4-F</b>	12 16 19	123 123 123	0,45 0,45 0,59
	<b>Vis et rondelles supplémentaires pour L/LUG/PEG</b>	rostfrei stainless inoxydables	<b>L1-F</b> <b>L1/2-FS</b> <b>L5/8-FS</b> <b>L3/4-FS</b> <b>L1-FS</b>	25 12 16 19 25	123 123 123 123 123	0,59 0,45 0,45 0,59 0,59
	<b>LUG</b> Profile Cleats Profils 		<b>LG1-1/2-C</b>	38	100	3,00
			<b>LG-2-C</b>	51	100	3,21
			<b>PG2</b>	51	100	1,95
			<b>PG3</b>	76	100	3,13
	<b>PEG</b> Profile Cleats Profils 		<b>A10</b> <b>B10</b> <b>C10</b>	10X200 mm	13X10 16X12 26X16	0,45 0,59 1,49
			<b>A10S</b> <b>B10S</b> <b>C10S</b>	10X200 mm	13X10 16X12 26X16	0,45 0,59 1,49
			<b>CW1024</b> <b>CWS1024</b> <b>CW25/100</b> <b>CWS25/100</b>	L/LUG/PEG L/LUG/PEG HD/EC HD/EC	100 100 100 100	0,20 0,20 0,40 0,40
	<b>GUIDE</b> Profile / Cleats Profils 	Schwarz, verzinkte Schrauben Black, plated Fasteners Noir, vis galvanisées				
		Schwarz, rostfreie Schrauben Black, stainless Fasteners Noir, vis inoxydables				
	<b>Extra Unterlegscheiben Extra Washers Rondelles supplémentaires</b> 	verzinkt, plated, galvanisées				
Rostfrei / Stainless / Inoxydable verzinkt, plated, galvanisées						

ANKER-FLEXCO GmbH  
Leidringer Straße 40 - 42  
D-72348 Rosenfeld

Telefon +49-74 28 - 94 06-0  
Telefax +49-74 28 - 94 06-260  
e-mail: [info@anker-flexco.de](mailto:info@anker-flexco.de)  
Internet: [www.anker-flexco.de](http://www.anker-flexco.de)

**ANKER  
FLEXCO**

TRANSPORTBAND-VERBINDUNGSSYSTEME  
CONVEYOR BELT FASTENING SYSTEMS  
SYSTÈMES D'AGRAFAGE POUR BANDES TRANSPORTEUSES